

ALUGARBE



Série de Portadas



CARACTERÍSTICAS

Na linha das portadas tradicionais, a série contém diversas soluções estéticas, técnicas e funcionais. Oferecendo diferentes opções consoante o meio envolvente e das características da região.

Largura do aro de 40 mm.

Largura da folha de 40 mm.

Permite lâminas fixas com ou sem furação.

Permite lâminas móveis.

A série de Portadas é uma forma prática e eficaz de responder ao mercado com a melhor relação qualidade/preço.

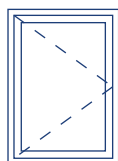
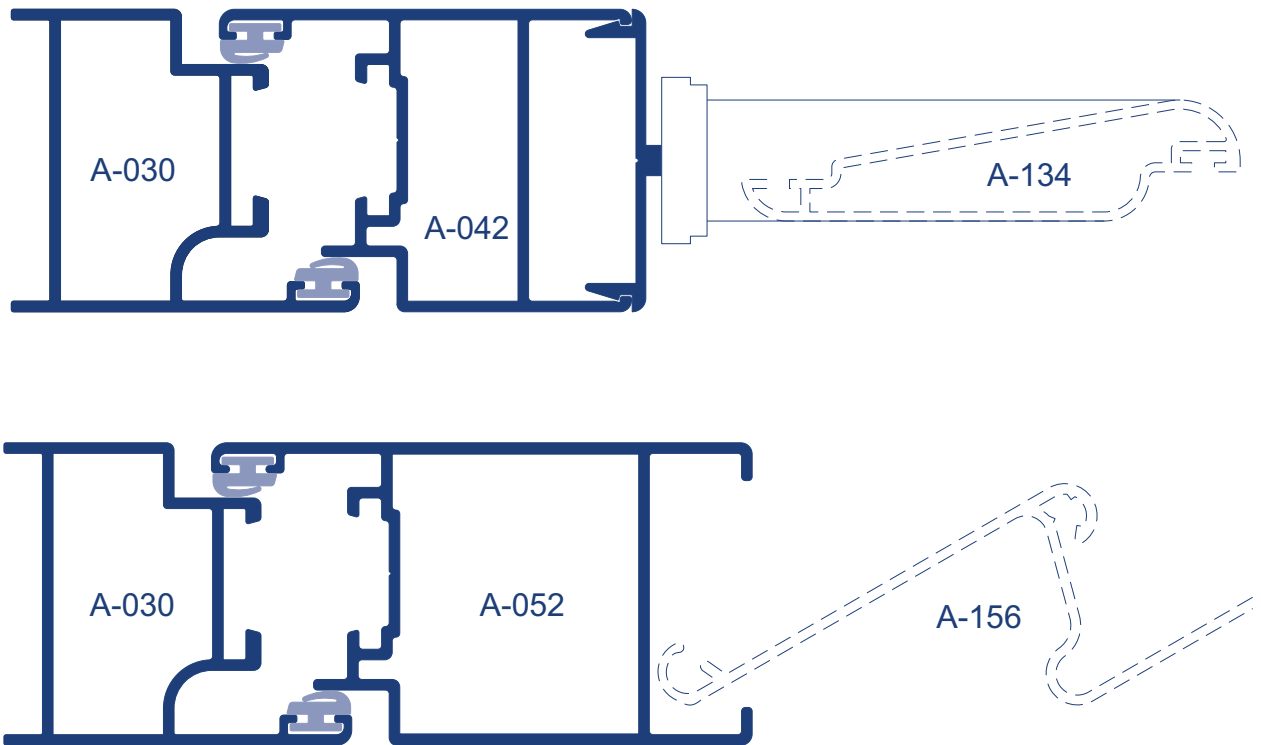

Abertura para o exterior

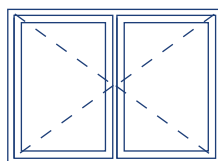

Abertura para o exterior

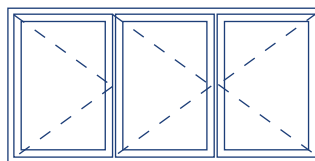

Abertura para o exterior

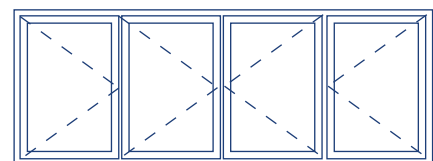

Abertura para o exterior



Referência	Secção	Descrição	Stock
A-030		Aro Fixo	•
A-032		Aro Móvel cx 30mm	•
A-033		Postiço Central	•
A-034		Travessa Pequena cx 30mm	
A-035		Travessa Grande cx 30mm	
A-041		Bite para Aro Móvel para A-134	•
A-042		Aro Móvel cx 36mm	•
A-043		Bite para Travessa para A-134	•
A-044		Travessa Pequena cx 31.6mm	
A-045		Travessa Grande cx 31.6mm	•
A-046		Bite para Travessa - Acabamento	•
A-047		Bite para Nylon para A-147	•
A-048		Bite para Aro Móvel para A-137	
A-049		Bite para Travessa para A-137	
A-051		Aro Fixo com Aba Interior	•
A-052		Aro Móvel (Grande) cx 30mm	•
A-062		Aro Móvel (Grande) cx 36mm	•
A-131		Persiana Dupla 24mm sem Furação	•
A-132		Persiana Móvel 71mm	•
A-133		Terminal Persiana para A-132	•
A-134		Persiana Móvel 66mm	•



Referência	Secção	Descrição	Stock
A-135		Terminal Persiana para A-134	•
A-136		Persiana Dupla com 24mm	•
A-137		Persiana Regulável	•
A-146		Bite para Persiana	
A-147		Persiana Tubular	
A-151		Persiana Dupla 29mm sem Furação	•
A-156		Persiana Dupla	•

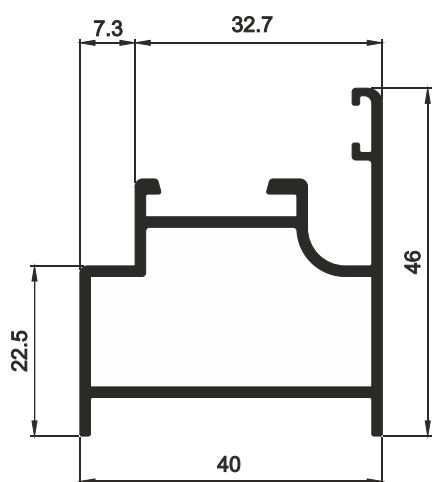

A - 030

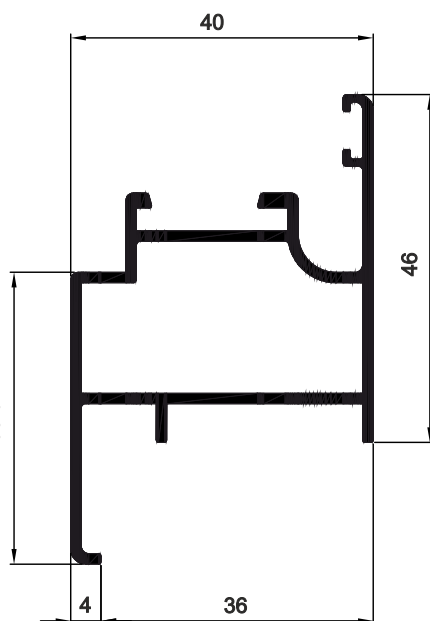

A - 051

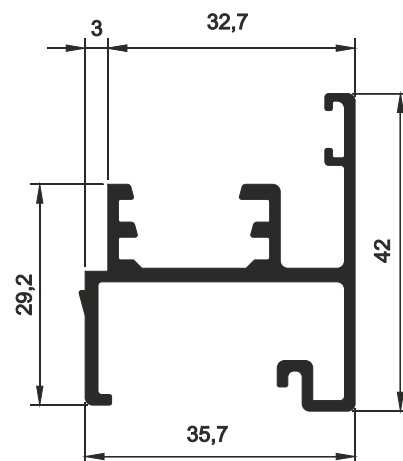

A - 033

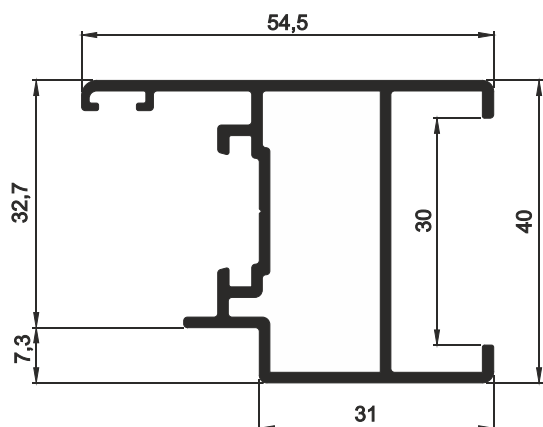

A - 032

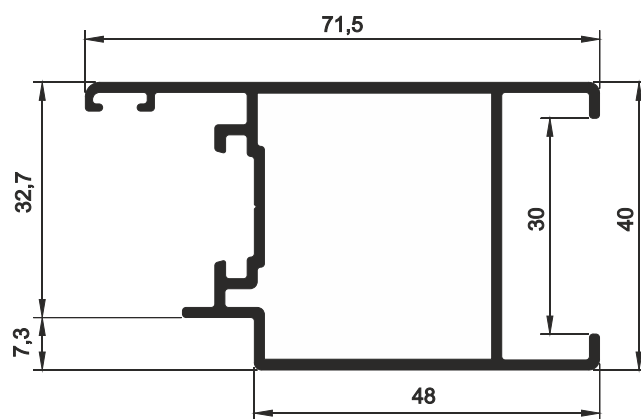

A - 052

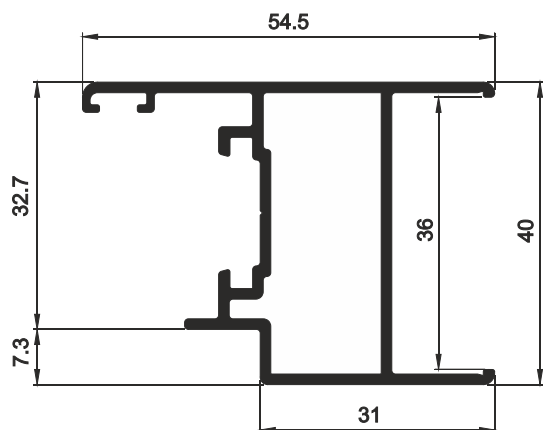

A - 042

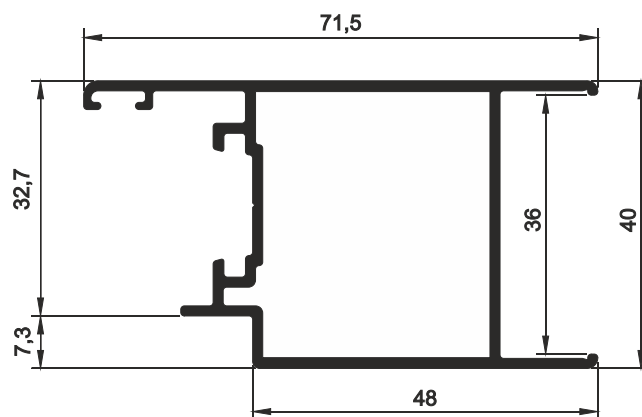

A - 062

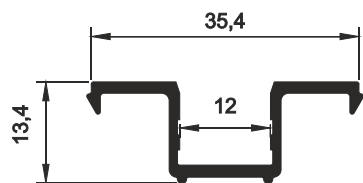

A - 041

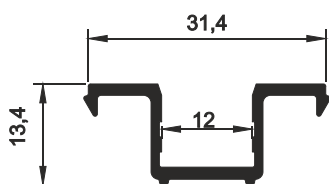

A - 043

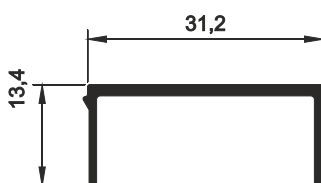

A - 046

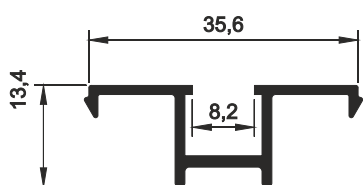

A - 047

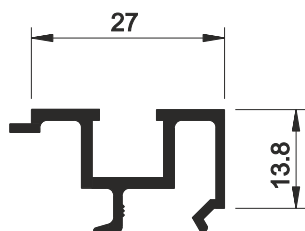

A - 146

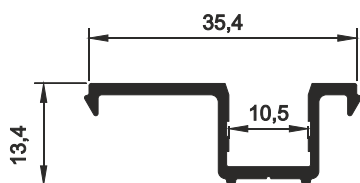

A - 048

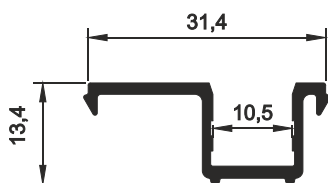

A - 049

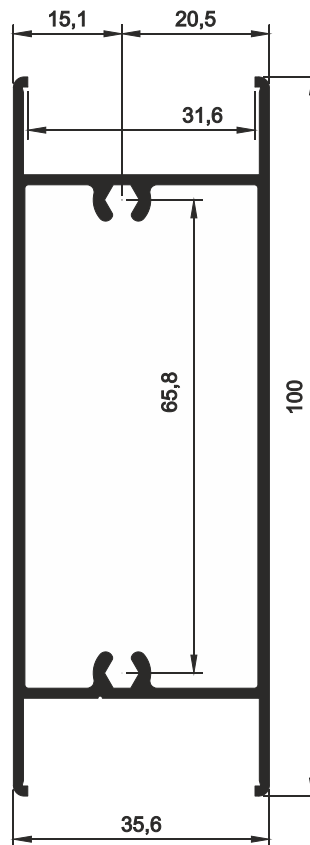

A - 045

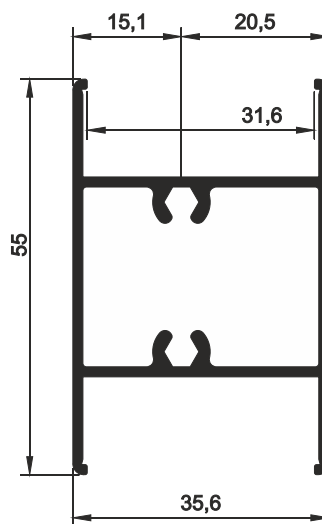

A - 044

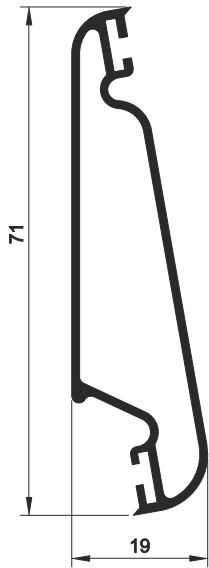

A - 132

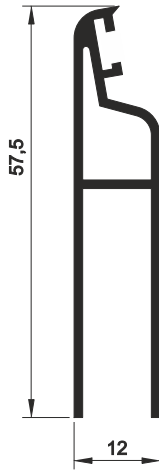

A - 133

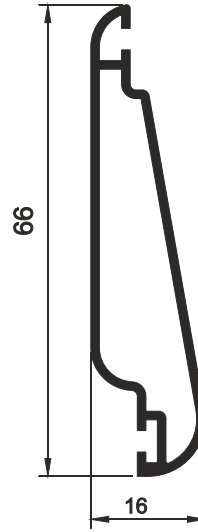

A - 134

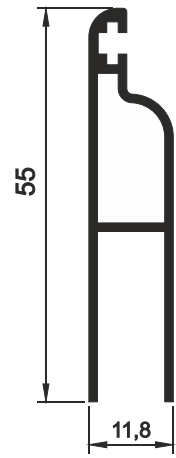

A - 135

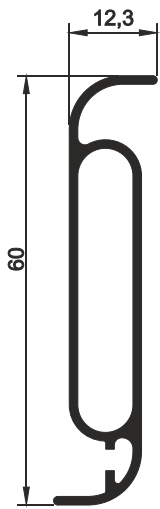

A - 137

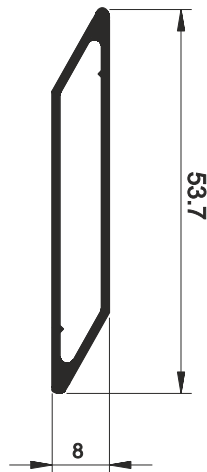

A - 147

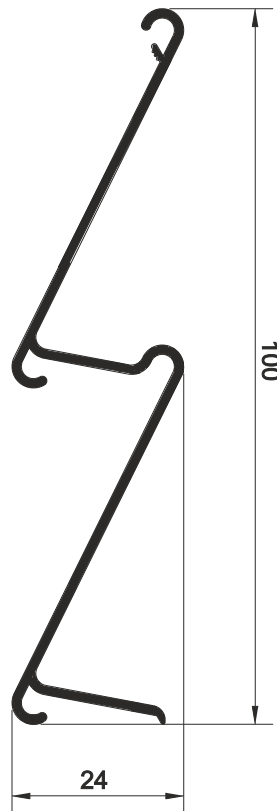

A - 136 C / FURAÇÃO
A - 131 S / FURAÇÃO

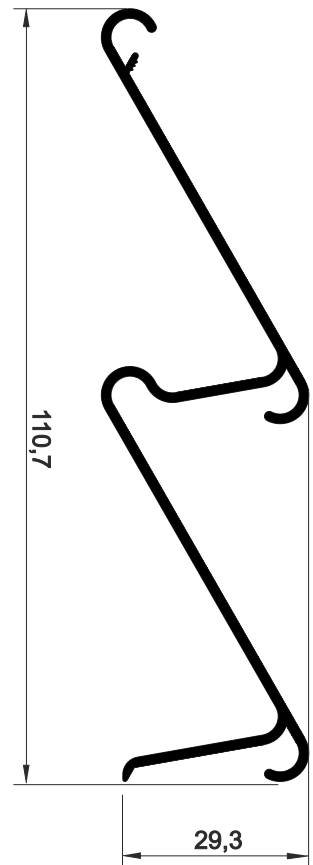

A - 156 C / FURAÇÃO
A - 151 S / FURAÇÃO

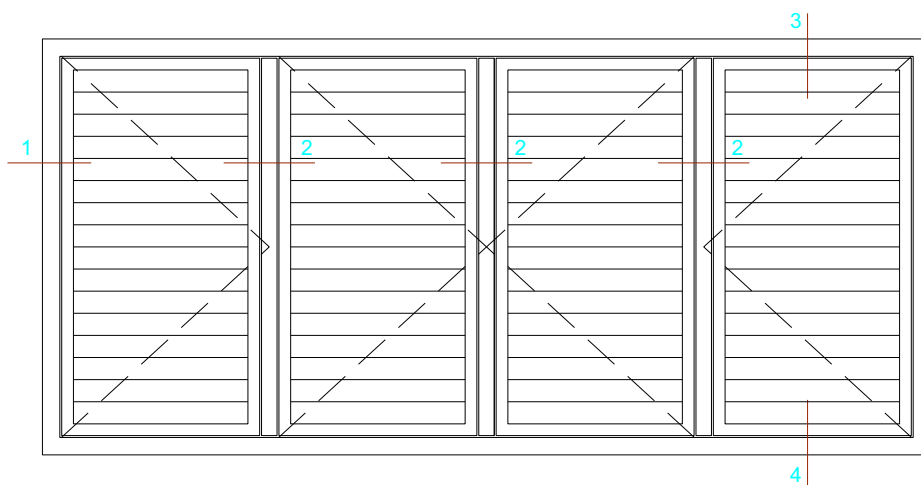
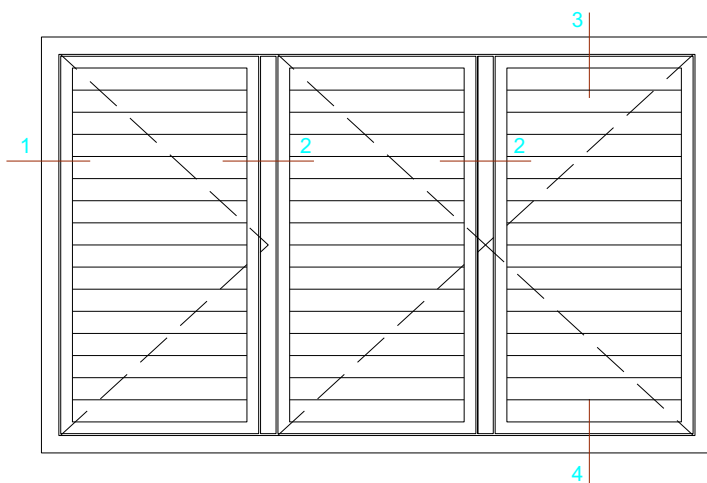
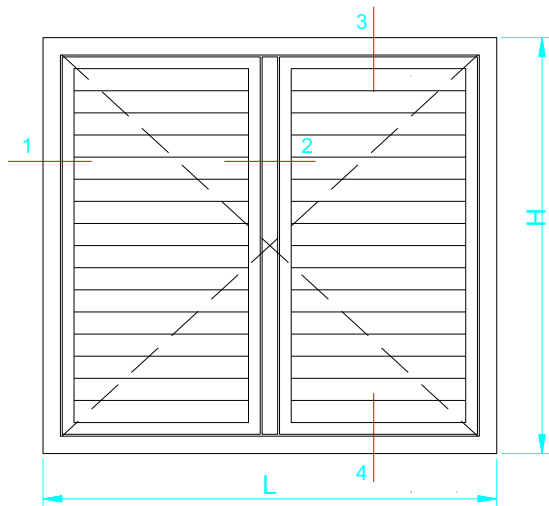

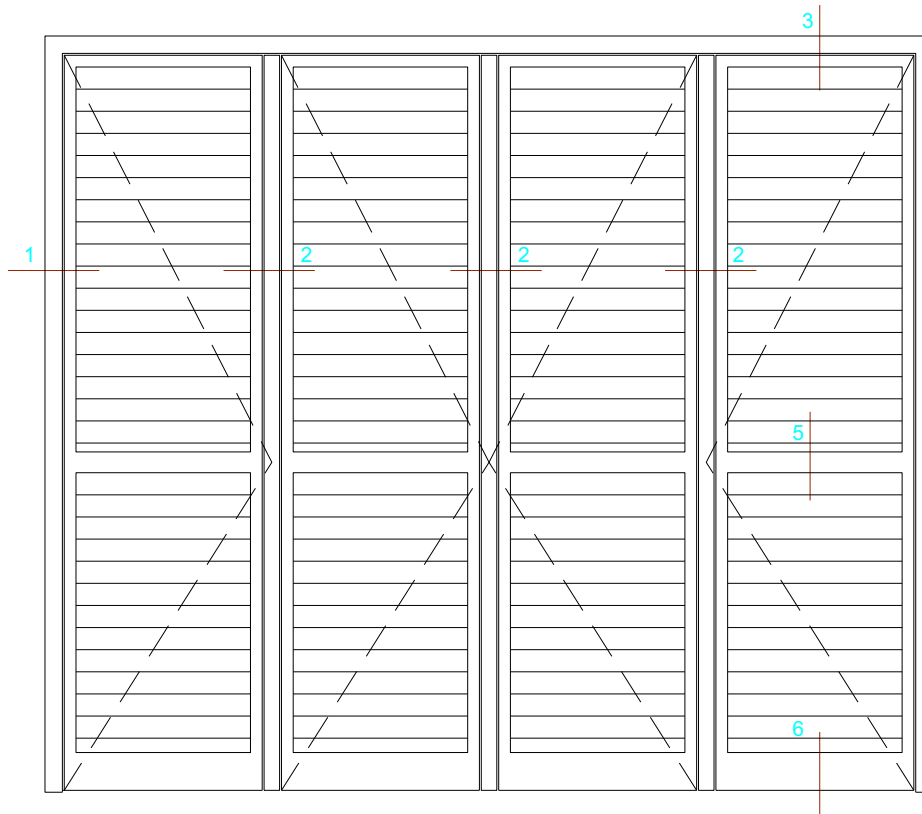
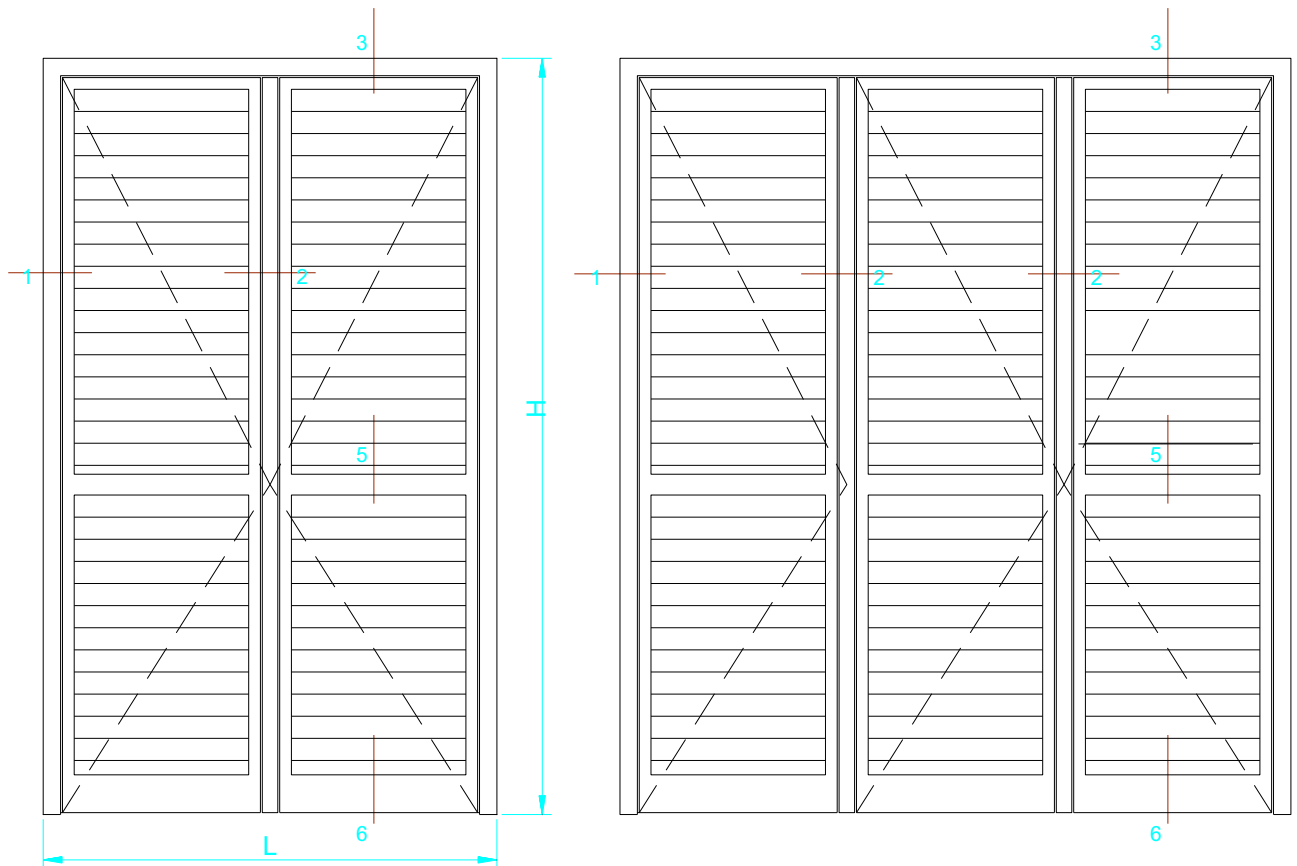



Portada de Peito com Duas Folhas e Aro Completo

Designação	Ref ^a	Fórmula (mm)	Peças
Aro Fixo	A - 030	L	2
		H	2
Aro Móvel	A - 042	$(L - 60) / 2$	4
		H - 55	4
	A - 032	$(L - 60) / 2$	4
		H - 55	4
	A - 052	$(L - 60) / 2$	4
		H - 55	4
	A - 062	$(L - 60) / 2$	4
		H - 55	4
Postiço Central 2 Folhas	A - 033	H - 102	1
Lamelas e Postiços	Opção	Ajustar	

Portada de Sacada com Duas Folhas sem Aro Inferior

Designação	Ref ^a	Fórmula (mm)	Peças
Aro Fixo	A - 030	L	1
		H	2
Aro Móvel	A - 062	$(L - 60) / 2$	2
		H - 33	4
	A - 052	$(L - 60) / 2$	2
		H - 33	4
	A - 042	$(L - 60) / 2$	2
		H - 33	4
	A - 032	$(L - 60) / 2$	2
		H - 33	4
Travessa ao Meio	A - 044	$(L - 292) / 2$	2
Travessa em Baixo	A - 045	$(L - 292) / 2$	2
Postiço Central 2 Folhas	A - 033	H - 56	1
Lamelas e Postiços	Opção	Ajustar	



Portada de Peito com Duas Folhas e Aro Completo

Designação	Refª	Fórmula (mm)	Peças
Aro Fixo	A - 042	L	2
		H	2
Aro Móvel	A - 042	$(L - 77) / 2$	4
		H - 72	4
	A - 032	$(L - 77) / 2$	4
		H - 72	4
	A - 052	$(L - 77) / 2$	4
		H - 72	4
	A - 062	$(L - 77) / 2$	4
		H - 72	4
Postiço Central 2 Folhas	A - 033	H - 119	1
Lamelas e Postiços	Opção	Ajustar	

Portada de Sacada com Duas Folhas sem Aro Inferior

Designação	Refª	Fórmula (mm)	Peças	
Aro Fixo	A - 042	L	1	
		H	2	
Aro Móvel	A - 062	$(L - 77) / 2$	2	
		H - 41	4	
	A - 052	$(L - 77) / 2$	2	
		H - 41	4	
	A - 042	$(L - 77) / 2$	2	
		H - 41	4	
	A - 032	$(L - 77) / 2$	2	
		H - 41	4	
	Travessa ao Meio	A - 044	$(L - 309) / 2$	2
	Travessa em Baixo	A - 045	$(L - 309) / 2$	2
Postiço Central 2 Folhas	A - 033	H - 65	1	
Lamelas e Postiços	Opção	Ajustar		

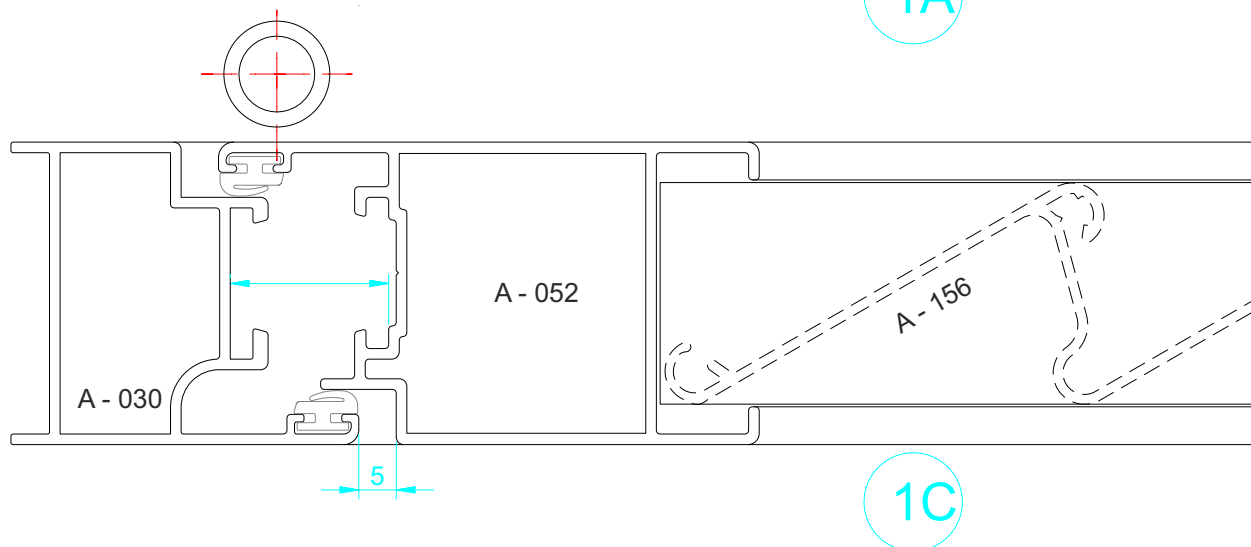
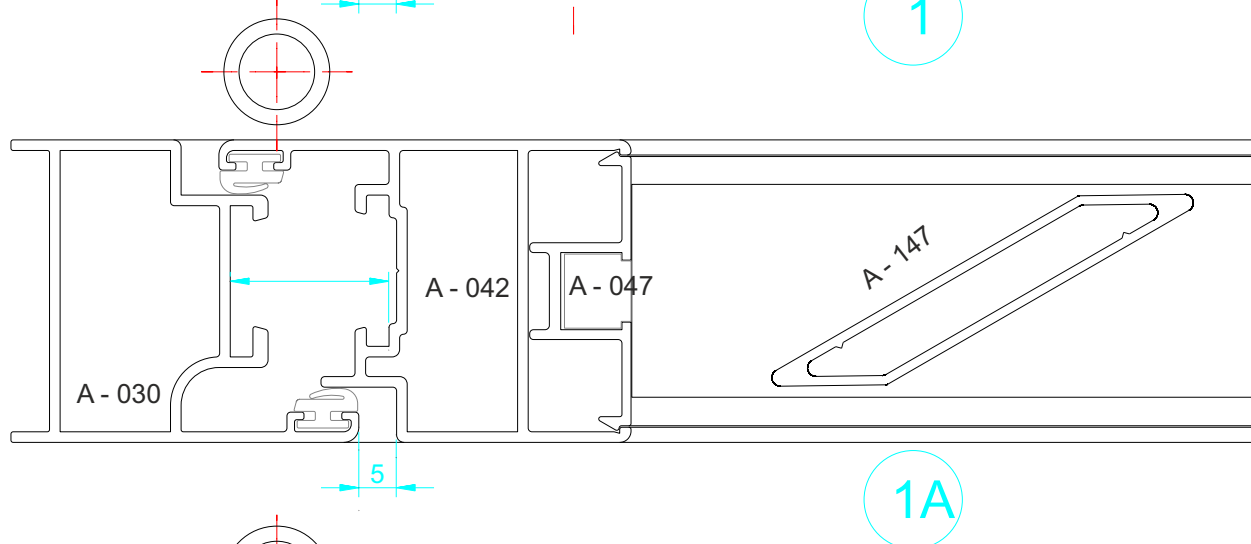
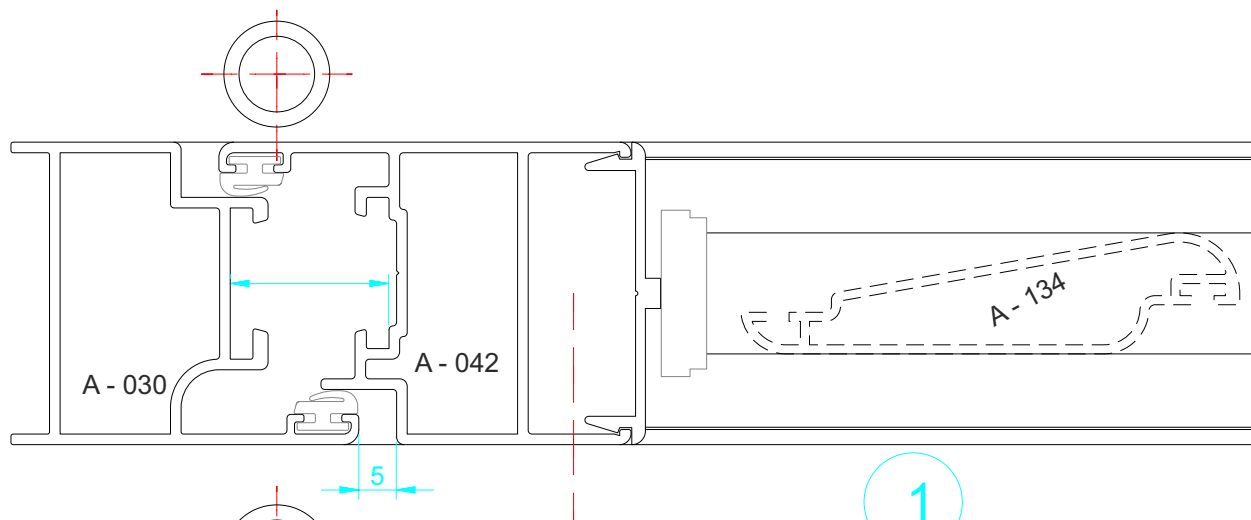

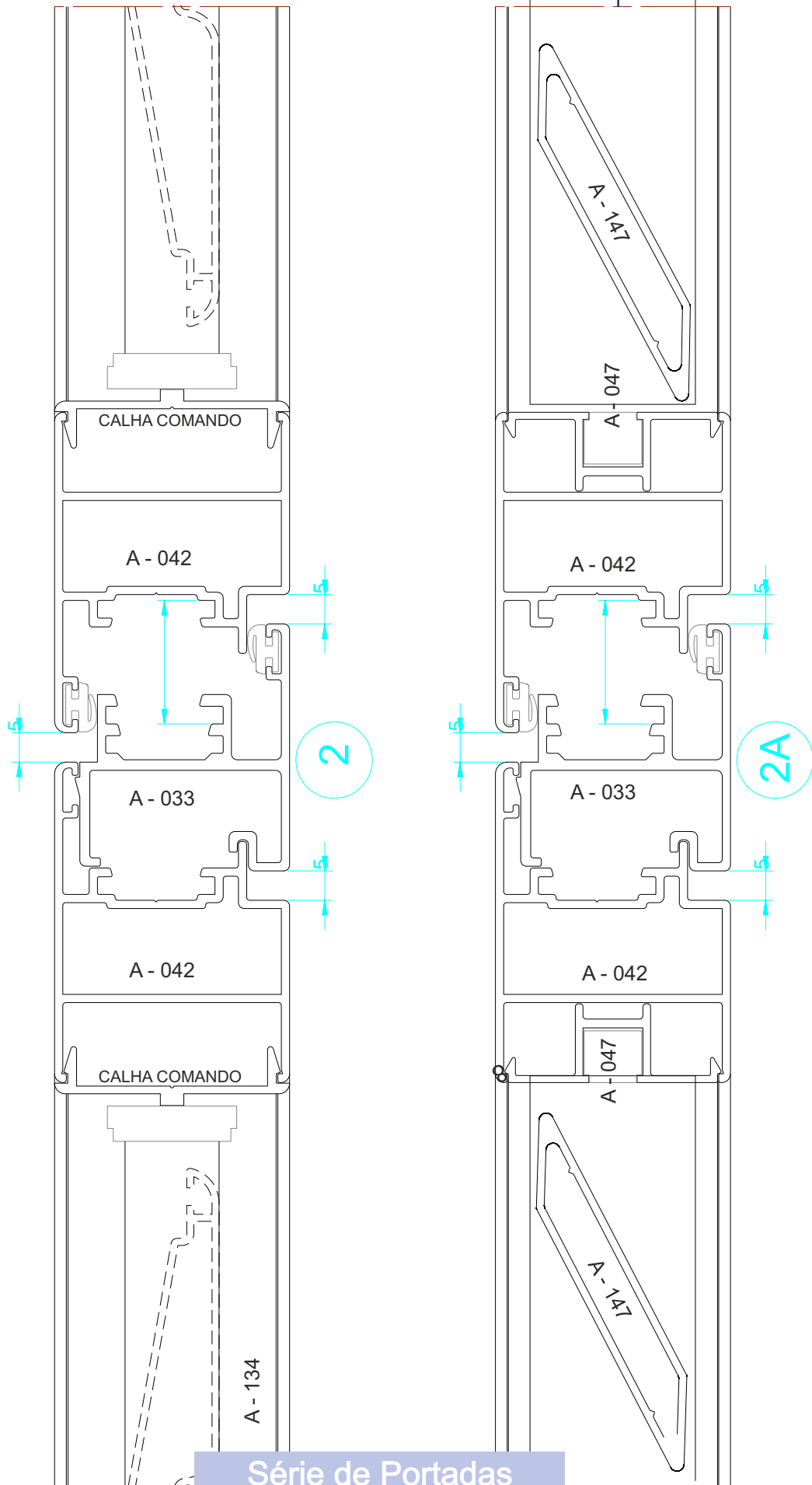

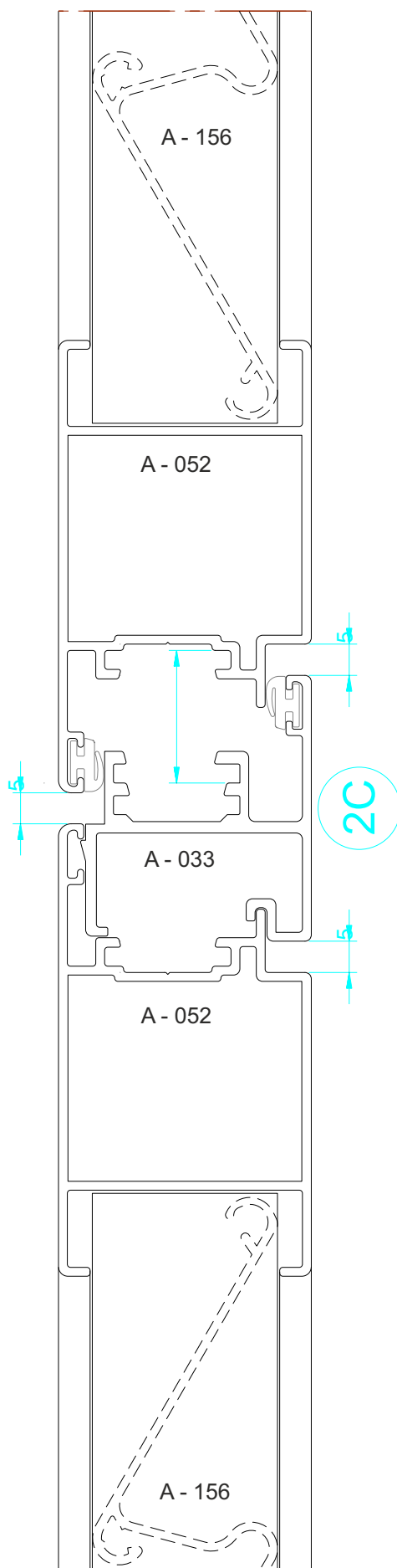

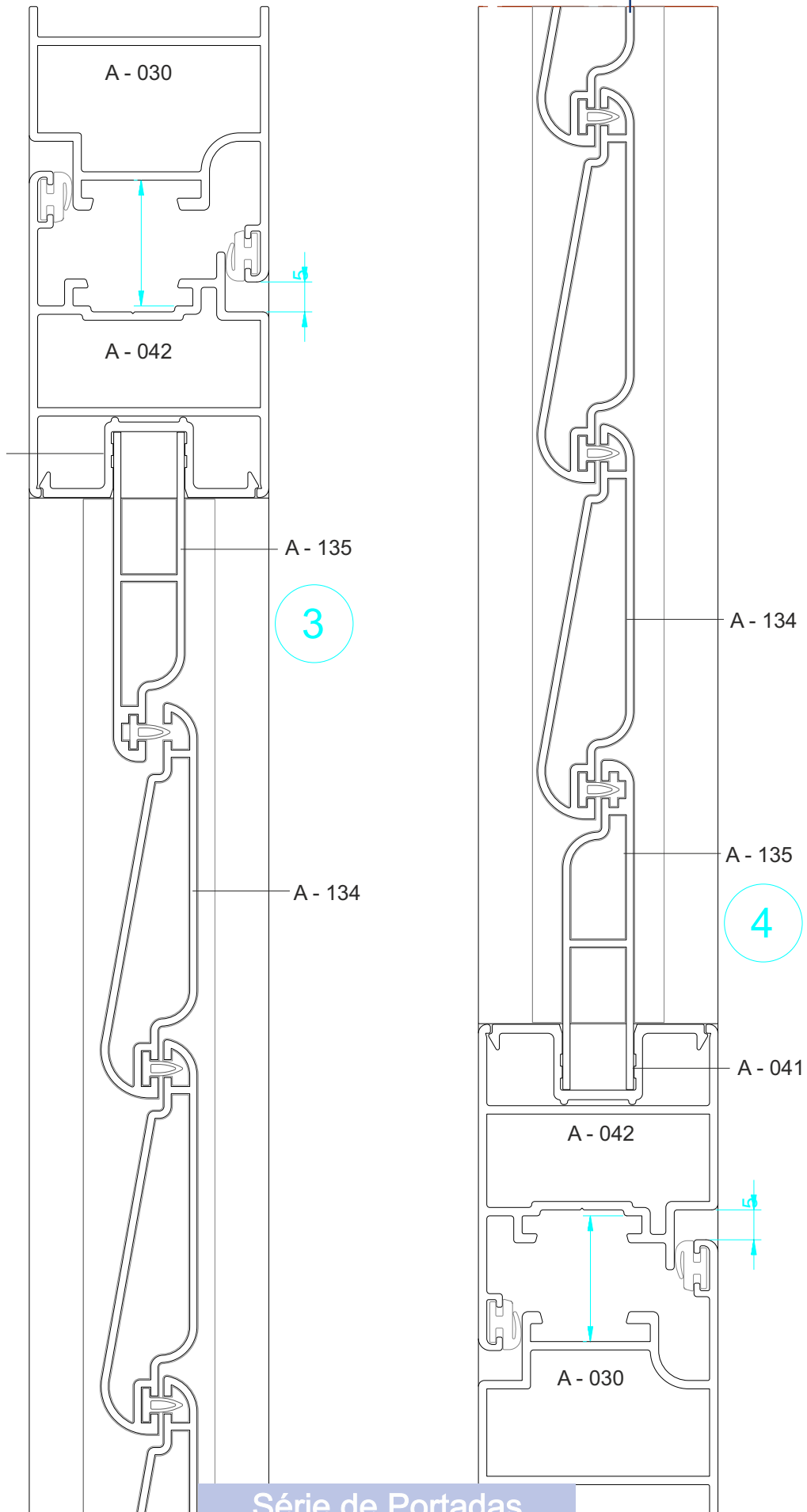

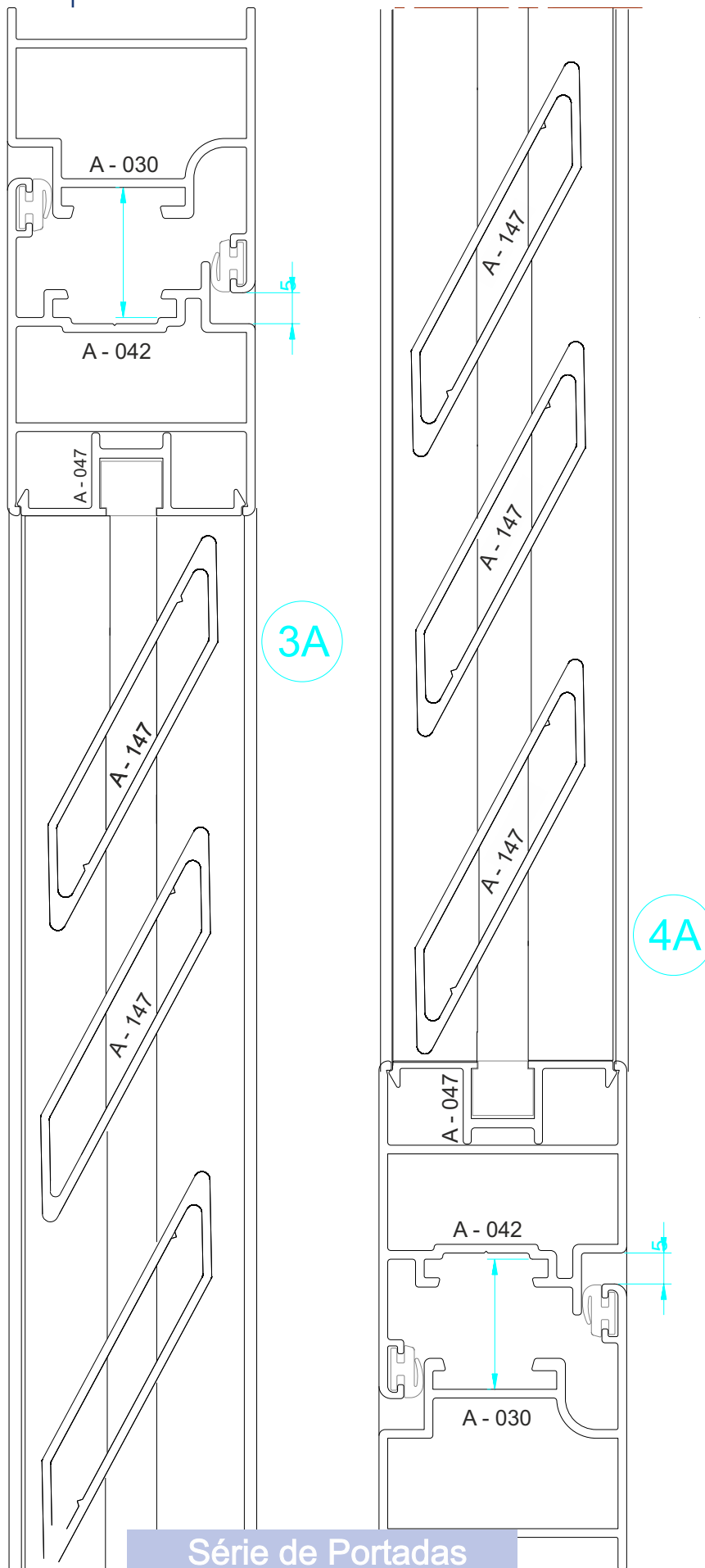

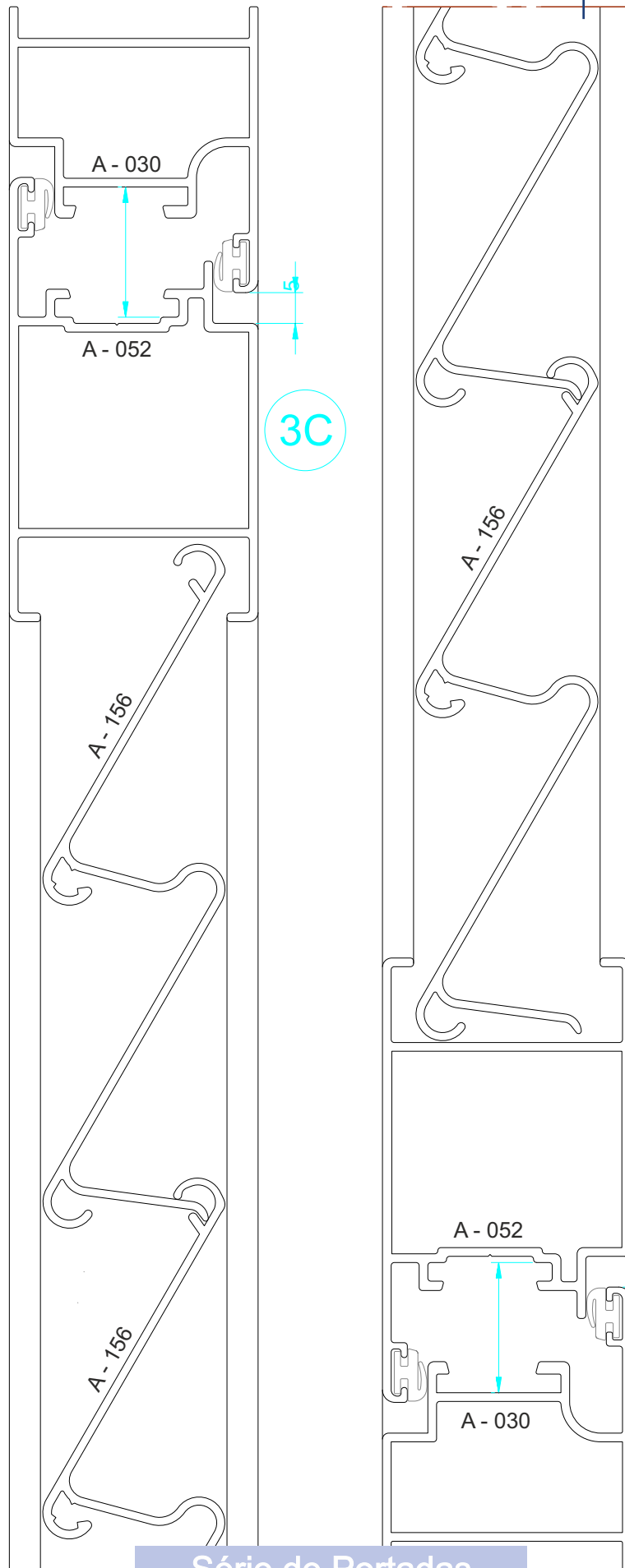

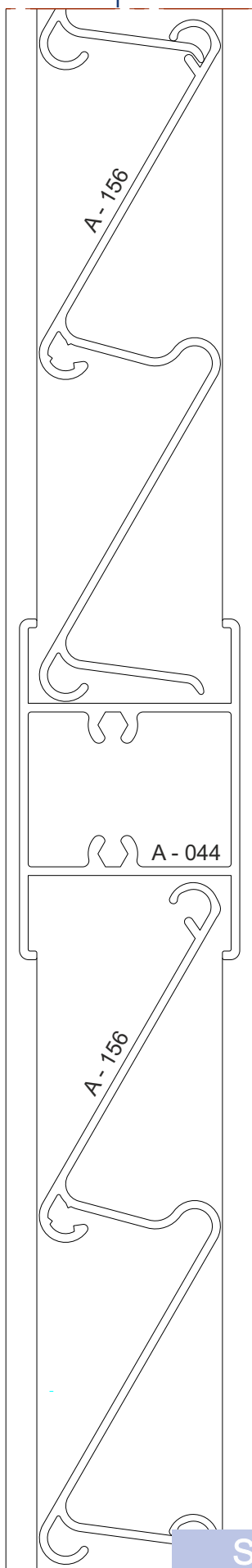

5C

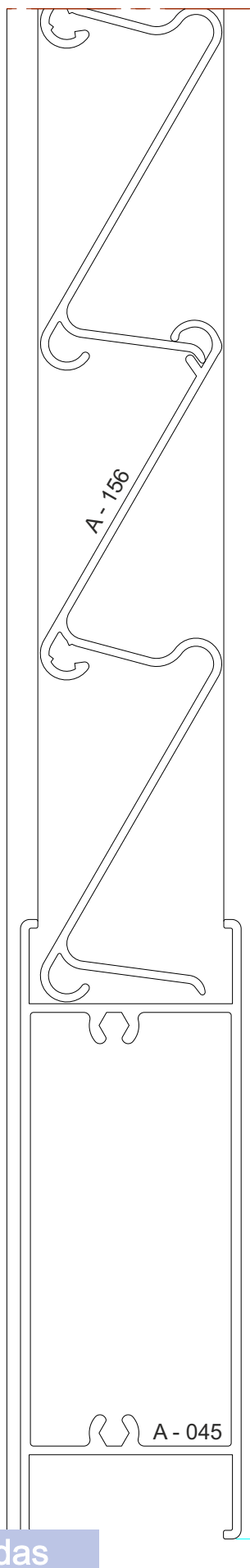

6C

45



Acessórios Série Portadas HP

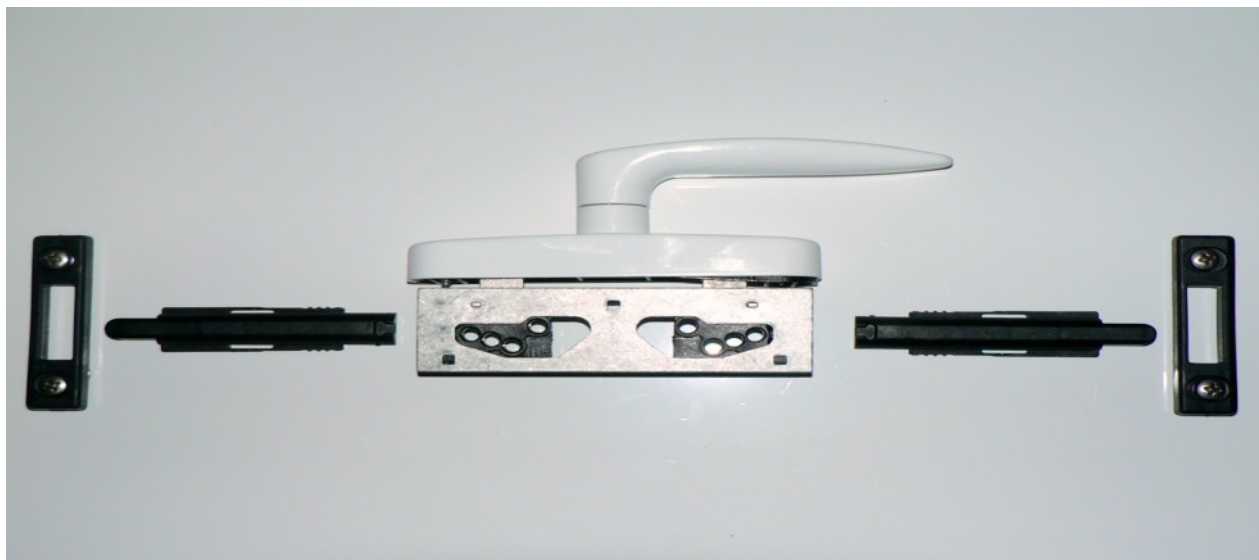

Conjunto Cremone e
Kits



Dobradiça
HP Balanço
3 nós



Dobradiça
HPA



Dobradiça
HP Balanço
4189/7



Conjunto Topo Vedação para
A 033

Acessórios Série Portadas HP



Mecanismo Maxi 55 para Portada Móvel



Esquadro para
Ângulos



Esquadro Grande
3631



Esquadro Pequeno
3614



Fixador Simples
900



Fixador Duplo
900/2

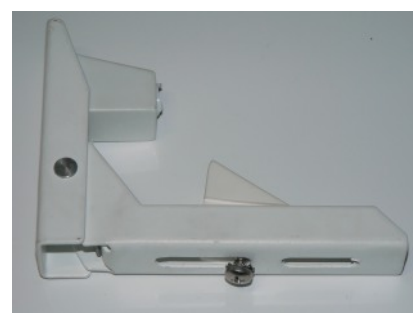

Fixador de Alumínio